

Composite dry sliding bushings, metric dimensions

Principal dimensions			Basic load ratings		Mass	Designation
d	D	B	dynamic C	static C0		
mm			kN		kg	-
30	34	20	46,5	143	0,03	PCM 303420 E

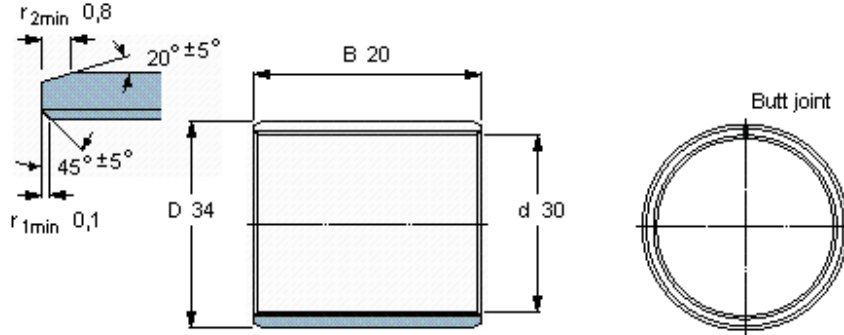

Specific load factor	K 80
Material constant	K_M 480